

船戸一丁目

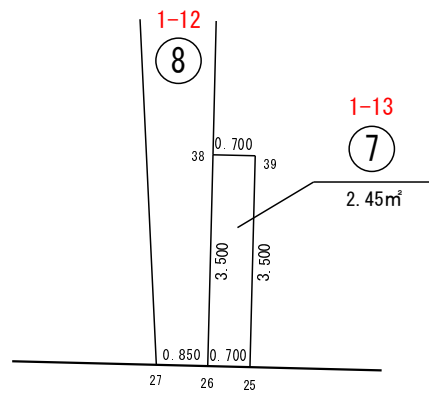
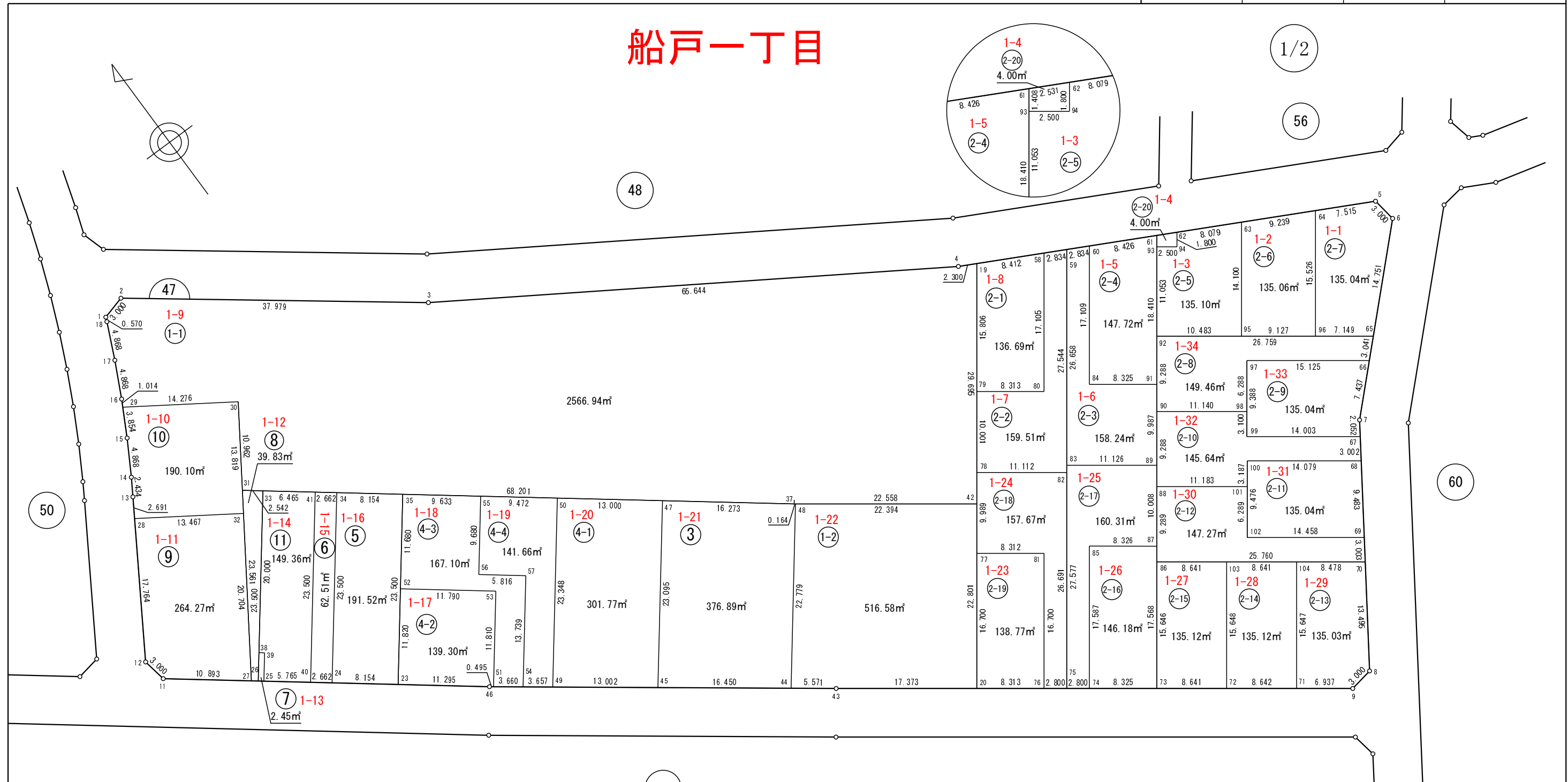

この図は、参考図で境界を証明するものではありません。
柏市役所

凡例	
	街区番号
	画地位置 (①は画地番号)
	画地面積 (m²)
	辺長 (m)

座 標 一 覧 表

測点名	X座標	Y座標
47-1	-10,112.701	10,979.740
47-2	-10,111.930	10,982.639
47-3	-10,134.925	11,012.865
47-4	-10,170.233	11,068.204
47-5	-10,194.369	11,114.455
47-6	-10,197.338	11,114.890
47-7	-10,214.937	11,096.814
47-8	-10,240.619	11,079.390
47-9	-10,241.125	11,076.433
47-11	-10,152.846	10,958.919
47-12	-10,149.893	10,958.395
47-13	-10,132.553	10,969.247
47-14	-10,130.490	10,970.538
47-15	-10,126.283	10,972.988
47-16	-10,122.001	10,975.303
47-17	-10,117.647	10,977.480
47-18	-10,113.226	10,979.518
47-19	-10,171.297	11,070.243
47-20	-10,213.529	11,039.060
47-23	-10,170.656	10,981.837
47-24	-10,165.653	10,975.399
47-25	-10,160.482	10,968.745
47-26	-10,160.053	10,968.192
47-27	-10,159.531	10,967.521
47-28	-10,134.834	10,967.819
47-29	-10,122.893	10,974.821
47-30	-10,130.821	10,986.693
47-31	-10,139.937	10,980.605
47-32	-10,142.313	10,979.018
47-33	-10,141.497	10,982.612
47-34	-10,147.097	10,989.819
47-35	-10,152.101	10,996.257
47-37	-10,181.786	11,034.457
47-38	-10,157.289	10,970.340
47-39	-10,157.719	10,970.893
47-40	-10,164.020	10,973.297
47-41	-10,145.464	10,987.717
47-42	-10,195.186	11,052.604
47-43	-10,203.208	11,025.084
47-44	-10,199.876	11,020.619
47-45	-10,190.037	11,007.436
47-46	-10,177.587	10,990.756
47-47	-10,171.801	11,021.607

測点名	X座標	Y座標
47-48	-10,181.884	11,034.588
47-49	-10,182.260	10,997.016
47-50	-10,163.824	11,011.343
47-51	-10,177.883	10,991.153
47-52	-10,161.323	10,989.090
47-53	-10,168.558	10,998.400
47-54	-10,180.072	10,994.085
47-55	-10,158.012	11,003.864
47-56	-10,165.655	10,997.924
47-57	-10,169.224	11,002.516
47-58	-10,175.189	11,077.701
47-59	-10,176.500	11,080.214
47-60	-10,177.811	11,082.726
47-61	-10,181.710	11,090.196
47-62	-10,182.880	11,092.440
47-63	-10,186.618	11,099.602
47-64	-10,190.892	11,107.793
47-65	-10,207.628	11,104.321
47-66	-10,209.749	11,102.142
47-67	-10,216.635	11,095.662
47-68	-10,219.119	11,093.976
47-69	-10,226.967	11,088.652
47-70	-10,229.452	11,086.966
47-71	-10,237.004	11,070.852
47-72	-10,231.871	11,063.900
47-73	-10,226.738	11,056.949
47-74	-10,221.793	11,050.252
47-75	-10,220.130	11,047.999
47-76	-10,218.466	11,045.747
47-77	-10,200.094	11,048.980
47-78	-10,192.058	11,054.914
47-79	-10,184.012	11,060.854
47-80	-10,188.950	11,067.541
47-81	-10,205.031	11,055.667
47-82	-10,198.658	11,063.853
47-83	-10,197.945	11,064.379
47-84	-10,191.575	11,072.564
47-85	-10,207.644	11,060.698
47-86	-10,214.151	11,066.243
47-87	-10,212.605	11,067.384
47-88	-10,206.678	11,071.760
47-89	-10,204.554	11,073.329
47-90	-10,199.206	11,077.277

測点名	X座標	Y座標
47-91	-10,196.520	11,079.261
47-92	-10,191.734	11,082.794
47-93	-10,182.843	11,089.359
47-94	-10,184.328	11,091.371
47-95	-10,197.961	11,091.227
47-96	-10,203.382	11,098.570
47-97	-10,200.765	11,089.974
47-98	-10,205.823	11,086.239
47-99	-10,208.317	11,084.397
47-100	-10,210.756	11,082.650
47-101	-10,213.320	11,080.757
47-102	-10,218.379	11,077.021
47-103	-10,219.283	11,073.195
47-104	-10,224.416	11,080.146

日本測地系

この図は、参考図で境界を証明するものではありません。
柏市役所

凡 例	
	街 区 番 号
	画 地 位 置 (①は画地番号)
	画地面積 (㎡)
	辺 長 (m)

船戸一丁目

この図は、参考図で境界を証明するものではありません。
柏市役所

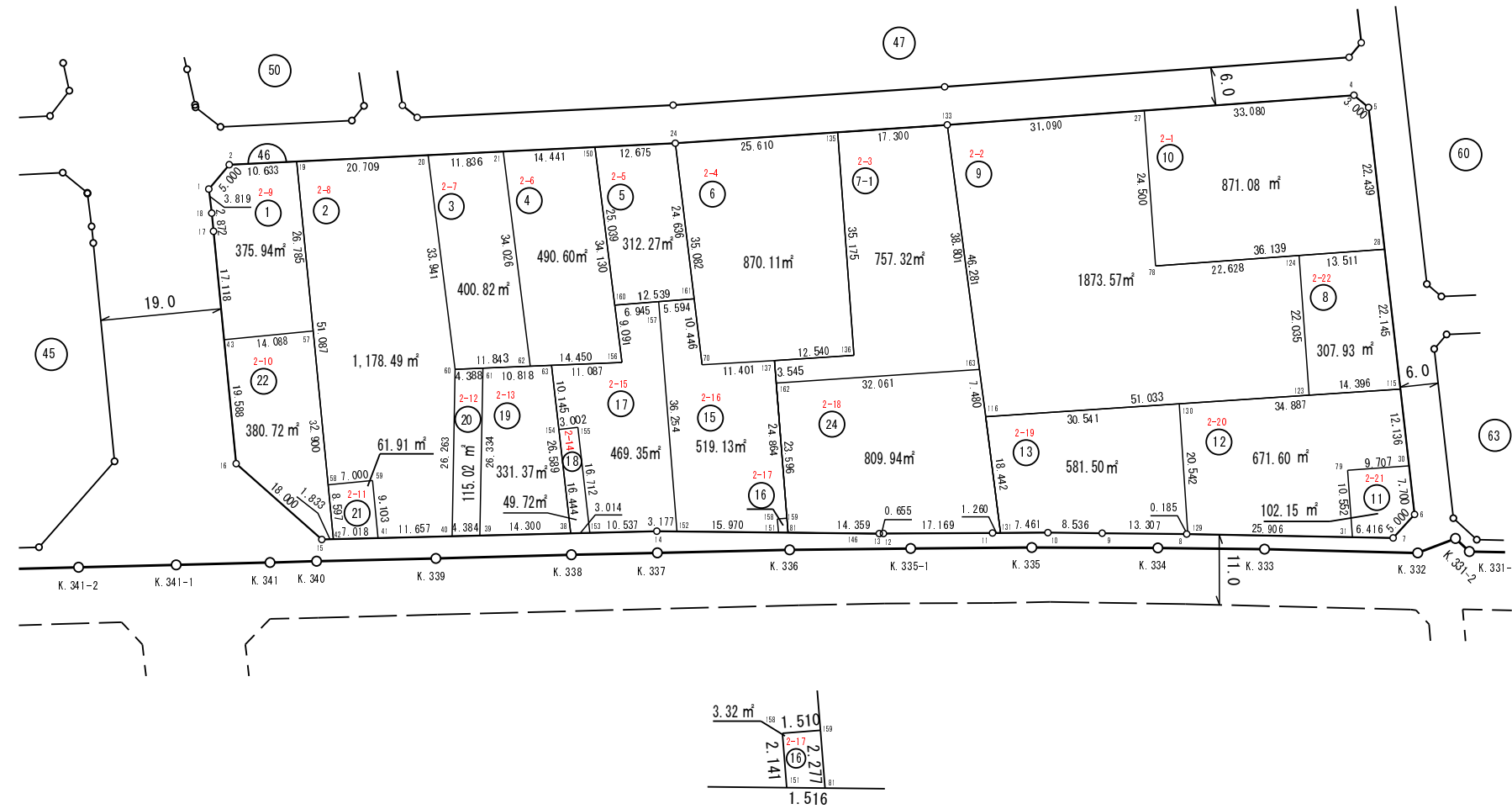
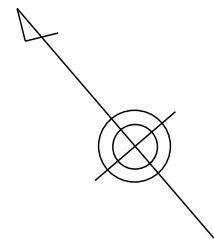

座標一覧表

測点名	X座標	Y座標
46-79	-10290.273	11033.982
46-81	-10240.399	10960.742
46-115	-10285.996	11048.604
46-116	-10246.790	10996.223
46-123	-10277.370	11037.079
46-124	-10259.644	11050.168
46-129	-10281.536	11008.365
46-130	-10265.091	11020.674
46-131	-10262.204	10986.098
46-133	-10208.026	11021.507
46-135	-10197.679	11007.644
46-136	-10225.979	10986.755
46-137	-10218.460	10976.720
46-150	-10174.583	10977.112
46-151	-10239.400	10959.602
46-152	-10228.875	10947.591
46-153	-10220.123	10937.034
46-154	-10204.599	10943.913
46-155	-10206.282	10946.399
46-156	-10203.062	10958.303
46-157	-10199.564	10968.927
46-158	-10237.669	10960.862
46-159	-10238.558	10962.082
46-160	-10195.477	10963.313
46-161	-10202.856	10973.450
46-162	-10221.325	10974.633
46-163	-10240.525	11000.309

日本測地系

測点名	X座標	Y座標
46-1	-10140.038	10926.681
46-2	-10139.227	10931.615
46-4	-10246.144	11073.130
46-5	-10249.101	11073.635
46-6	-10302.411	11037.467
46-7	-10303.028	11032.505
46-8	-10281.413	11008.227
46-9	-10272.647	10998.215
46-10	-10267.024	10991.793
46-11	-10261.390	10985.136
46-12	-10250.277	10972.049
46-13	-10249.863	10971.541
46-14	-10226.781	10945.202
46-15	-10193.457	10904.319
46-16	-10175.627	10901.849
46-17	-10145.575	10922.926
46-18	-10143.223	10924.575
46-19	-10145.751	10940.011
46-20	-10158.458	10956.363
46-21	-10165.721	10965.709
46-24	-10182.361	10987.120
46-27	-10226.494	11046.518
46-28	-10267.670	11061.037
46-30	-10296.039	11041.790
46-31	-10298.762	11027.714
46-38	-10218.219	10934.698
46-39	-10209.184	10923.614
46-40	-10206.414	10920.215
46-41	-10199.049	10911.179
46-42	-10194.615	10905.739
46-43	-10159.590	10913.096
46-57	-10167.680	10924.631
46-58	-10187.577	10910.676
46-59	-10191.596	10916.407
46-60	-10186.780	10937.658
46-61	-10189.497	10941.103
46-62	-10194.114	10946.957
46-63	-10196.197	10949.598
46-70	-10211.546	10967.654
46-78	-10246.203	11031.965

凡例	
	街区番号
	画地位置 (①は画地番号)
	画地面積 (㎡)
	辺長 (m)

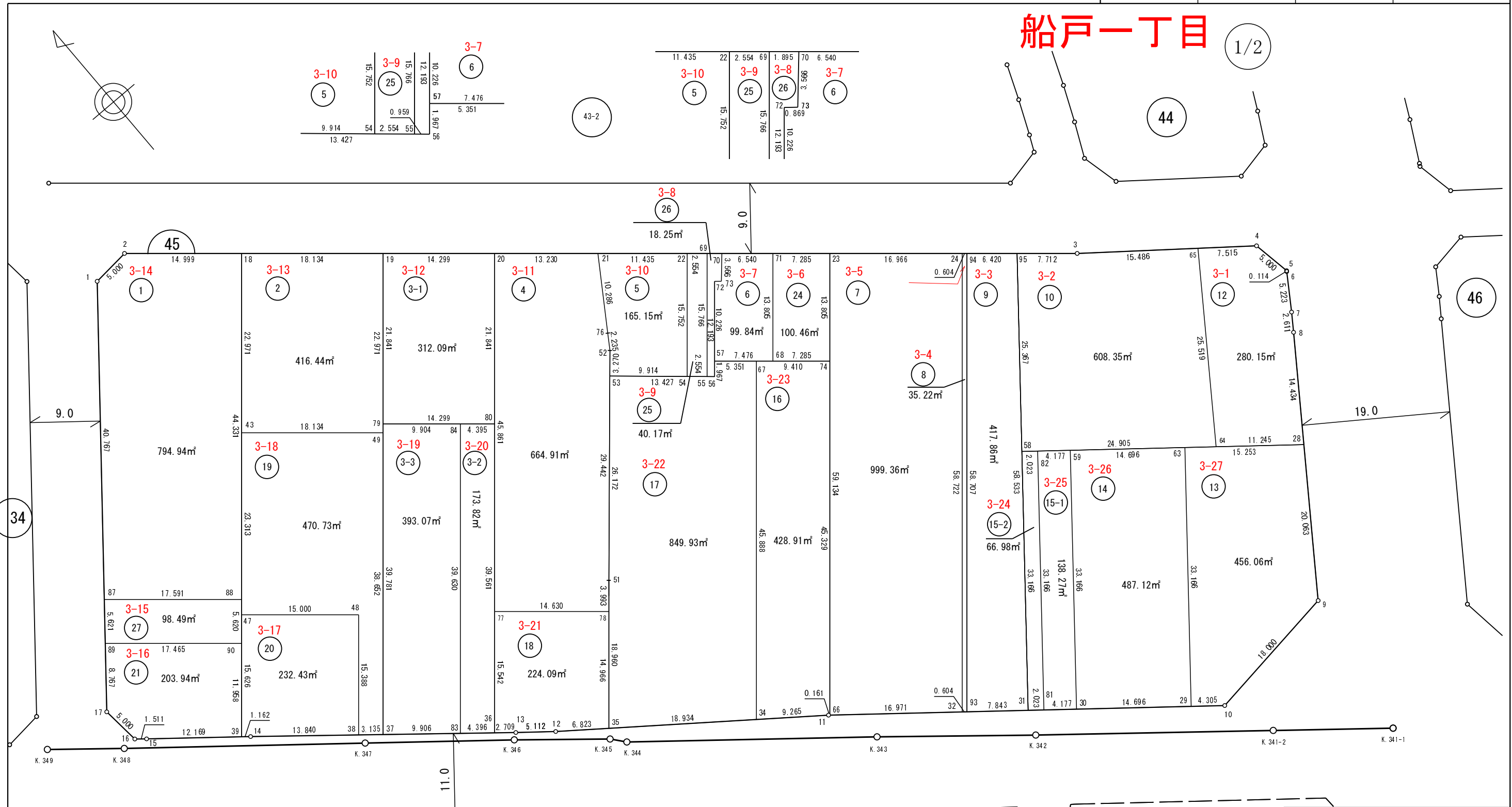

船戸一丁目 1/2

**この図は、参考図で境界を証明するものではありません。
柏市役所**

凡 例	
	街区番号
	画地位置 (①は画地番号)
	画地面積 (㎡)
	辺長 (m)

この図は、参考図で境界を証明するものではありません。
柏市役所

座 標 一 覧 表

測点名	X座標	Y座標
45-1	-10030.570	10794.649
45-2	-10030.104	10799.627
45-3	-10109.028	10892.755
45-4	-10123.141	10910.916
45-5	-10128.063	10911.795
45-6	-10128.160	10911.735
45-7	-10132.517	10908.855
45-8	-10134.665	10907.370
45-9	-10162.908	10887.561
45-10	-10165.424	10869.738
45-11	-10133.543	10830.213
45-12	-10112.542	10802.186
45-13	-10109.333	10798.207
45-14	-10087.762	10771.945
45-15	-10079.368	10761.590
45-16	-10078.404	10760.426
45-17	-10073.428	10759.931
45-18	-10039.801	10811.069
45-19	-10051.525	10824.904
45-20	-10060.770	10835.813
45-21	-10069.324	10845.905
45-22	-10076.717	10854.629
45-23	-10088.532	10868.570
45-24	-10099.501	10881.513
45-28	-10146.482	10899.082
45-29	-10162.721	10866.387
45-30	-10153.494	10854.948
45-31	-10149.602	10850.123
45-32	-10144.299	10843.548
45-34	-10127.987	10822.799
45-35	-10116.633	10807.646
45-36	-10107.614	10796.114
45-37	-10098.537	10785.063
45-38	-10096.547	10782.640
45-39	-10087.031	10771.043
45-43	-10057.325	10796.218
45-47	-10075.110	10781.146
45-48	-10084.808	10792.589

測点名	X座標	Y座標
45-49	-10069.049	10810.053
45-51	-10102.169	10819.905
45-52	-10079.797	10839.044
45-53	-10082.282	10836.918
45-54	-10088.734	10844.445
45-55	-10090.396	10846.384
45-56	-10091.020	10847.113
45-57	-10089.520	10848.384
45-58	-10123.787	10870.945
45-59	-10127.679	10875.771
45-63	-10136.906	10887.210
45-64	-10139.422	10890.329
45-65	-10118.530	10904.983
45-66	-10133.644	10830.339
45-67	-10092.979	10852.467
45-68	-10094.353	10854.087
45-69	-10078.368	10856.578
45-70	-10079.593	10858.023
45-71	-10083.822	10863.013
45-72	-10081.719	10854.996
45B-73	-10082.270	10855.667
45-74	-10099.063	10859.645
45-76	-10077.921	10840.259
45-77	-10095.757	10806.162
45-78	-10105.216	10817.323
45-79	-10068.188	10810.783
45-80	-10077.433	10821.692
45-81	-10150.872	10851.697
45-82	-10125.057	10872.520
45-83	-10104.824	10792.717
45-84	-10074.591	10818.339
45-87	-10062.248	10768.988
45-88	-10073.621	10782.408
45-89	-10066.616	10765.450
45-90	-10077.908	10778.774
45-93	-10144.678	10844.018
45-94	-10099.891	10881.974
45-95	-10104.042	10886.871

日本測地系

凡 例	
①	街区番号
①	画地位置 (①は画地番号)
1,234.00㎡	画地面積 (㎡)
9.000 2.500	辺長 (m)

船戸一丁目

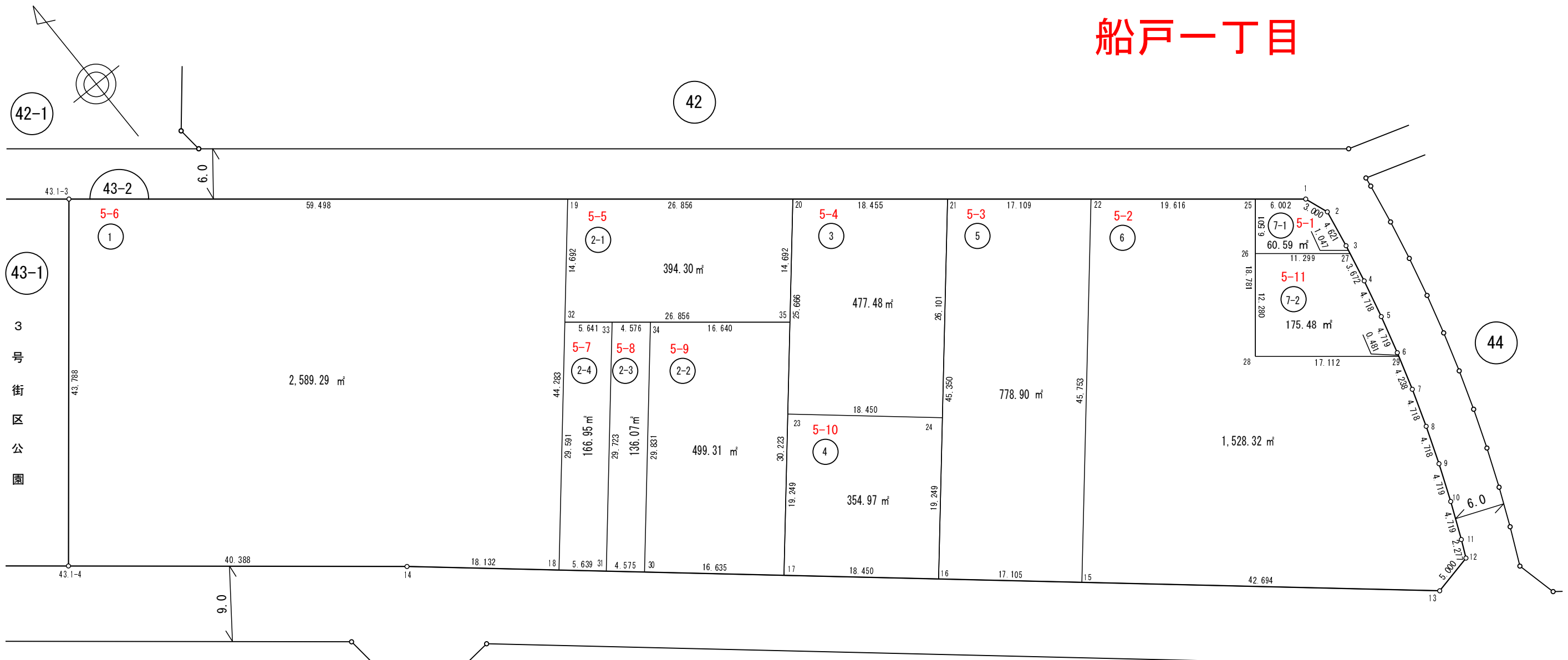

座標一覧表

測点名	X座標	Y座標	測点名	X座標	Y座標
43.1-3	-9,957.512	10,794.217	43.2-18	-10028.682	10811.870
43.1-4	-9,991.538	10,766.655	43.2-19	-9994.899	10840.501
43.2-1	-10,050.221	10,908.986	43.2-20	-10011.776	10861.392
43.2-2	-10,053.031	10,910.038	43.2-21	-10023.373	10875.749
43.2-3	-10,057.582	10,909.234	43.2-22	-10034.124	10889.058
43.2-4	-10,062.203	10,908.279	43.2-23	-10031.356	10844.798
43.2-5	-10,066.794	10,907.190	43.2-24	-10042.285	10858.874
43.2-6	-10,071.352	10,905.967	43.2-25	-10046.450	10904.318
43.2-7	-10,075.872	10,904.612	43.2-26	-10051.507	10900.233
43.2-8	-10,080.350	10,903.126	43.2-27	-10058.607	10909.022
43.2-9	-10,084.783	10,901.511	43.2-28	-10061.060	10892.517
43.2-10	-10,089.168	10,899.767	43.2-29	-10071.813	10905.829
43.2-11	-10,093.500	10,897.896	43.2-30	-10035.286	10819.662
43.2-12	-10,095.563	10,896.932	43.2-31	-10032.328	10816.172
43.2-13	-10,096.631	10,892.048	43.2-32	-10006.108	10831.002
43.2-14	-10,016.960	10,798.038	43.2-33	-10009.653	10835.390
43.2-15	-10,069.028	10,859.477	43.2-34	-10012.528	10838.949
43.2-16	-10,057.970	10,846.429	43.2-35	-10022.984	10851.893
43.2-17	-10,046.041	10,832.353			

凡例	
	街区番号
	画地位置 (①は画地番号)
	画地面積 (㎡)
	辺長 (m)

この図は、参考図で境界を証明するものではありません。
柏市役所

船戸一丁目

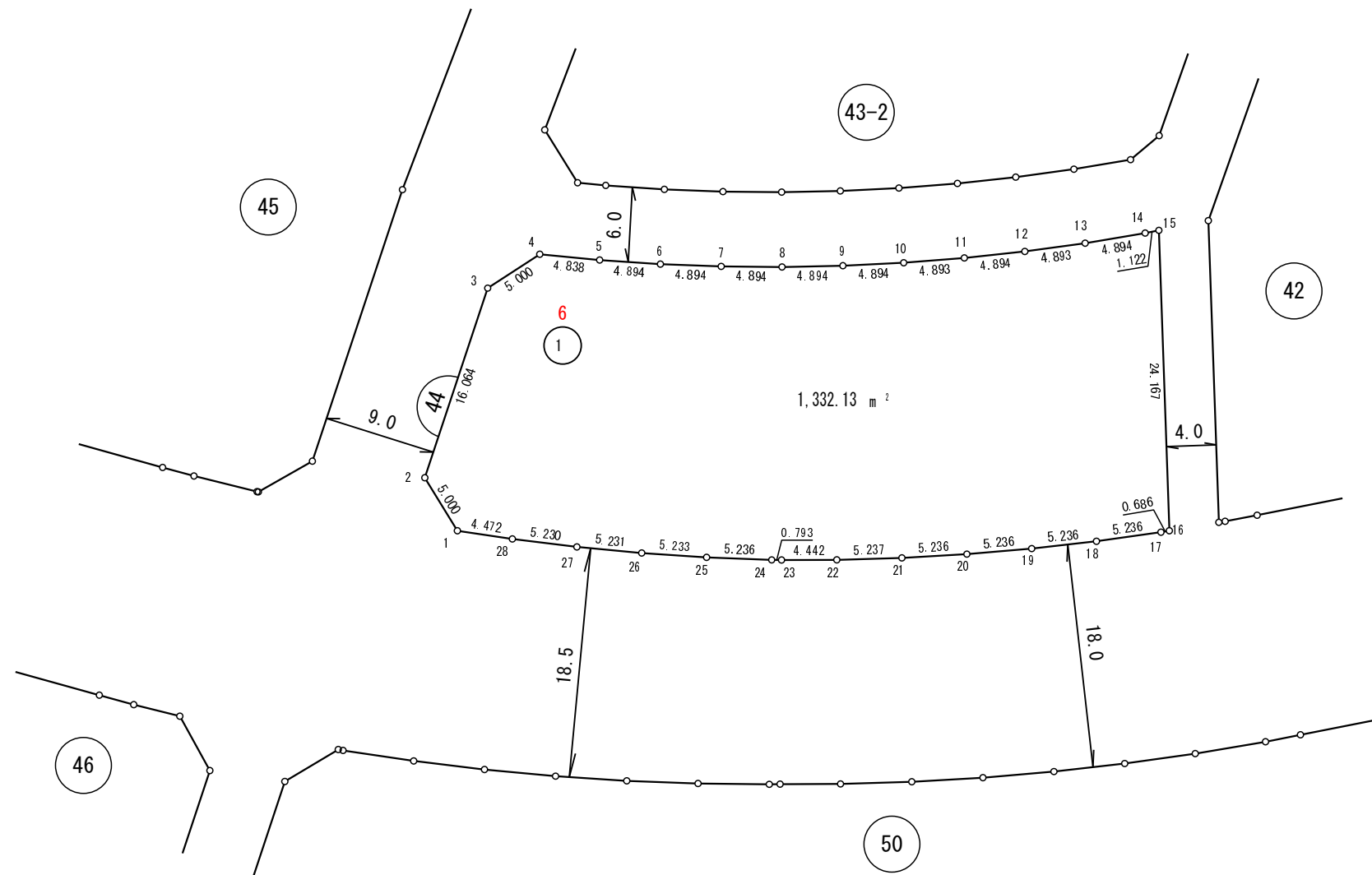
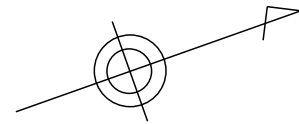

座標一覧表

測点名	X座標	Y座標
44-1	-10,114.022	10,920.084
44-2	-10,115.067	10,915.194
44-3	-10,105.210	10,902.510
44-4	-10,100.349	10,901.338
44-5	-10,095.966	10,903.385
44-6	-10,091.473	10,905.325
44-7	-10,086.926	10,907.134
44-8	-10,082.328	10,908.810
44-9	-10,077.683	10,910.351
44-10	-10,072.995	10,911.756
44-11	-10,068.269	10,913.024
44-12	-10,063.507	10,914.154
44-13	-10,058.715	10,915.145
44-14	-10,053.895	10,915.995
44-15	-10,052.785	10,916.158
44-16	-10,060.058	10,939.205
44-17	-10,060.733	10,939.087
44-18	-10,065.864	10,938.044
44-19	-10,070.965	10,936.862
44-20	-10,076.031	10,935.540
44-21	-10,081.059	10,934.079
44-22	-10,086.046	10,932.481
44-23	-10,090.238	10,931.011
44-24	-10,090.982	10,930.737
44-25	-10,095.845	10,928.795
44-26	-10,100.649	10,926.722
44-27	-10,105.394	10,924.519
44-28	-10,110.074	10,922.185

日本測地系

この図は、参考図で境界を証明するものではありません。
柏市役所

凡例	
	街区番号
	画地位置 (①は画地番号)
	画地面積 (㎡)
	辺長 (m)

船戸一丁目

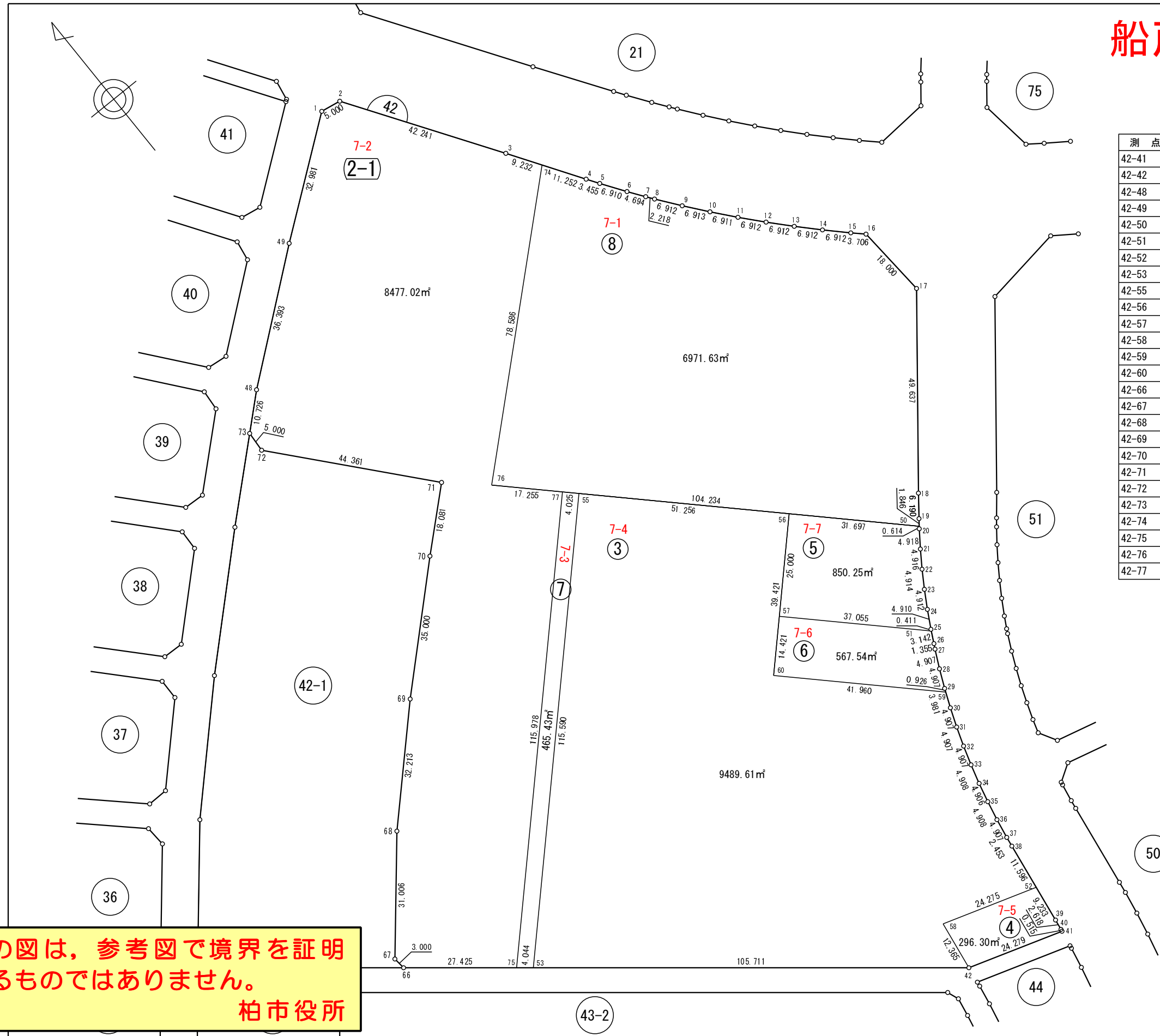

座標一覧表

測点名	X座標	Y座標	測点名	X座標	Y座標
42-41	-10056.082	10939.899	42-1	-9788.490	10925.128
42-42	-10048.776	10916.746	42-2	-9789.322	10930.058
42-48	-9831.085	10870.375	42-3	-9824.482	10953.470
42-49	-9808.427	10898.855	42-4	-9841.617	10964.695
42-50	-9957.887	10974.669	42-5	-9844.496	10966.605
42-51	-9979.490	10960.993	42-6	-9850.192	10970.518
42-52	-10043.852	10941.725	42-7	-9854.000	10973.261
42-53	-9982.349	10834.512	42-8	-9855.790	10974.571
42-55	-9899.812	10915.437	42-9	-9861.276	10978.776
42-56	-9935.696	10952.036	42-10	-9866.667	10983.103
42-57	-9953.548	10934.534	42-11	-9871.960	10987.547
42-58	-10036.547	10918.575	42-12	-9877.153	10992.109
42-59	-9993.221	10954.399	42-13	-9882.244	10996.784
42-60	-9963.845	10924.437	42-14	-9887.230	11001.571
42-66	-9962.575	10810.033	42-15	-9892.108	11006.468
42-67	-9959.589	10809.739	42-16	-9894.664	11009.151
42-68	-9935.772	10829.591	42-17	-9912.621	11010.404
42-69	-9912.872	10852.246	42-18	-9951.521	10979.571
42-70	-9888.915	10877.762	42-19	-9956.425	10975.795
42-71	-9876.788	10891.174	42-20	-9958.374	10974.295
42-72	-9843.270	10862.115	42-21	-9962.362	10971.416
42-73	-9838.279	10862.419	42-22	-9966.434	10968.663
42-74	-9832.204	10958.529	42-23	-9970.589	10966.038
42-75	-9979.808	10831.367	42-24	-9974.820	10963.543
42-76	-9884.914	10900.242	42-25	-9979.125	10961.182
42-77	-9896.994	10912.562	42-26	-9982.283	10959.554

日本測地系

この図は、参考図で境界を証明するものではありません。
柏市役所

凡例	
	街区番号
	画地位置 (①は画地番号)
	画地面積 (m²)
	辺長 (m)

船戸一丁目

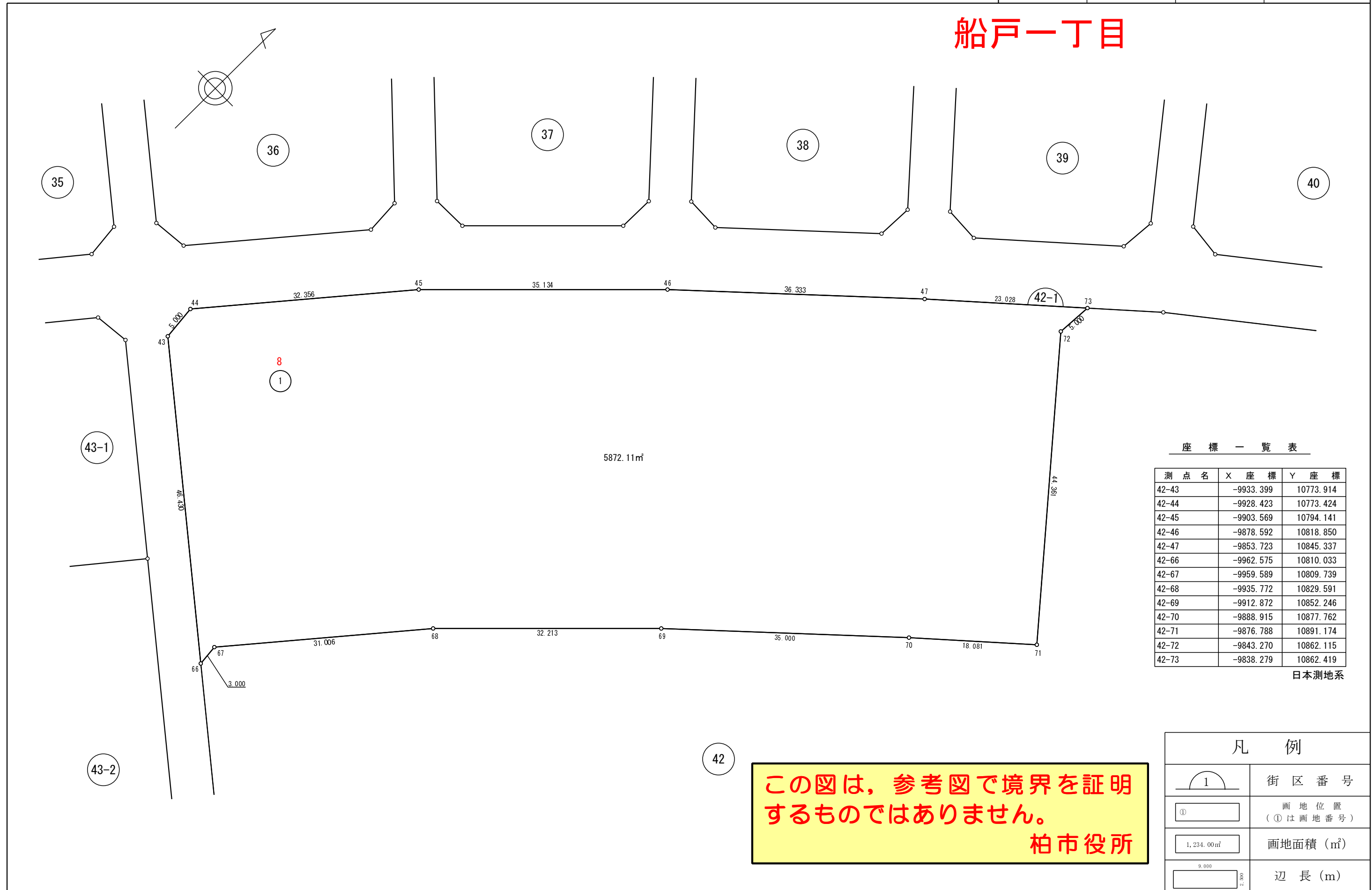

座標一覧表

測点名	X座標	Y座標
42-43	-9933.399	10773.914
42-44	-9928.423	10773.424
42-45	-9903.569	10794.141
42-46	-9878.592	10818.850
42-47	-9853.723	10845.337
42-66	-9962.575	10810.033
42-67	-9959.589	10809.739
42-68	-9935.772	10829.591
42-69	-9912.872	10852.246
42-70	-9888.915	10877.762
42-71	-9876.788	10891.174
42-72	-9843.270	10862.115
42-73	-9838.279	10862.419

日本測地系

この図は、参考図で境界を証明するものではありません。
柏市役所

凡例

	街区番号
	画地位置 (①は画地番号)
	画地面積 (㎡)
	辺長 (m)

船戸一丁目

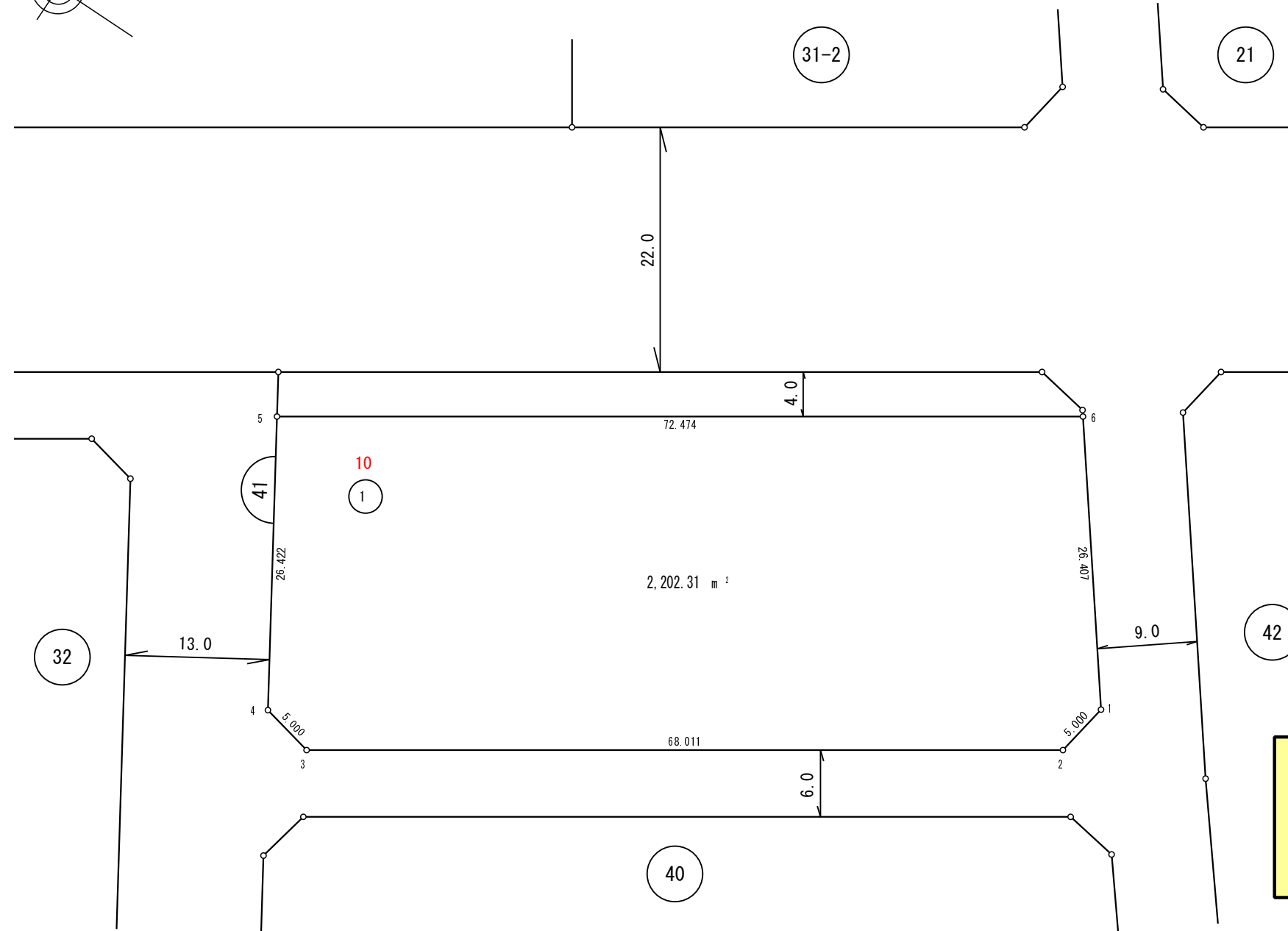
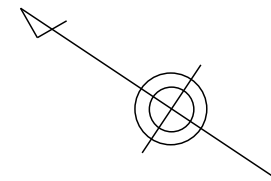

座標一覧表

測点名	X座標	Y座標
41-1	-9,797.164	10,898.809
41-2	-9,796.333	10,893.879
41-3	-9,739.723	10,856.185
41-4	-9,734.837	10,857.243
41-5	-9,720.877	10,879.677
41-6	-9,781.201	10,919.845

日本測地系

この図は、参考図で境界を証明するものではありません。
柏市役所

凡例

	街区番号
	画地位置 (①は画地番号)
	画地面積 (㎡)
	辺長 (m)

船戸一丁目

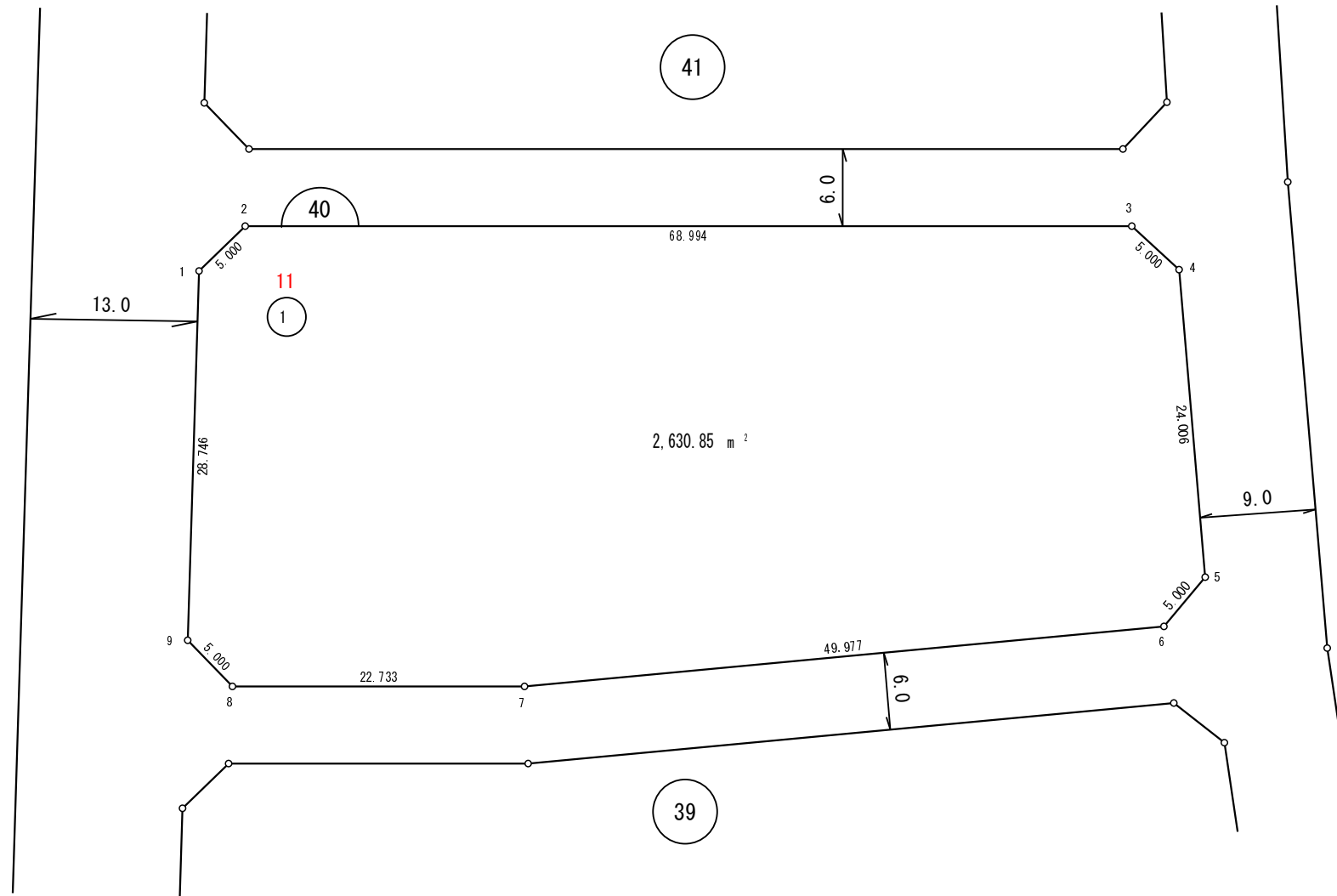
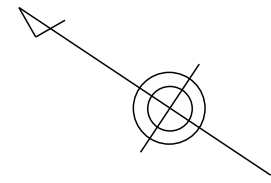

座標一覧表

測点名	X座標	Y座標
40-1	-9,741.745	10,846.141
40-2	-9,742.804	10,851.027
40-3	-9,800.232	10,889.267
40-4	-9,805.171	10,888.492
40-5	-9,820.117	10,869.705
40-6	-9,819.574	10,864.735
40-7	-9,780.741	10,833.275
40-8	-9,761.819	10,820.675
40-9	-9,756.932	10,821.734

日本測地系

この図は、参考図で境界を証明するものではありません。
 柏市役所

凡例	
	街区番号
	画地位置 (①は画地番号)
	画地面積 (㎡)
	辺長 (m)

船戸一丁目

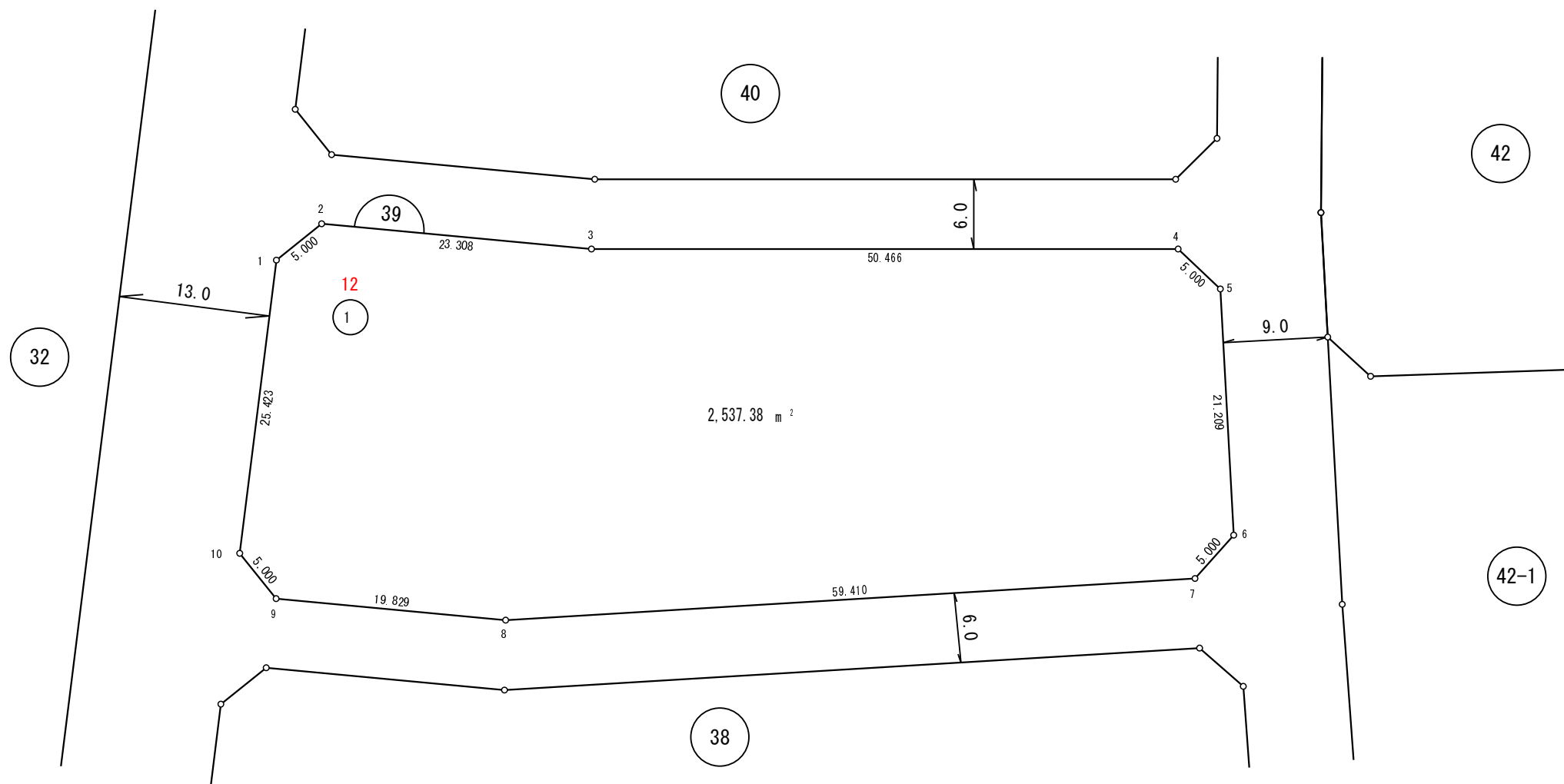
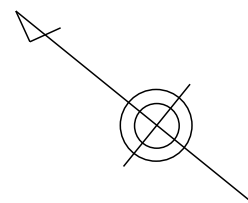

座標一覧表

測点名	X座標	Y座標
39-1	-9,763.840	10,810.631
39-2	-9,764.899	10,815.518
39-3	-9,784.300	10,828.436
39-4	-9,823.513	10,860.204
39-5	-9,828.498	10,859.818
39-6	-9,842.721	10,844.086
39-7	-9,842.485	10,839.091
39-8	-9,798.663	10,798.978
39-9	-9,782.158	10,787.988
39-10	-9,777.271	10,789.046

日本測地系

この図は、参考図で境界を証明するものではありません。
柏市役所

凡例

	街区番号
	画地位置 (①は画地番号)
	画地面積 (m ²)
	辺長 (m)

船戸一丁目

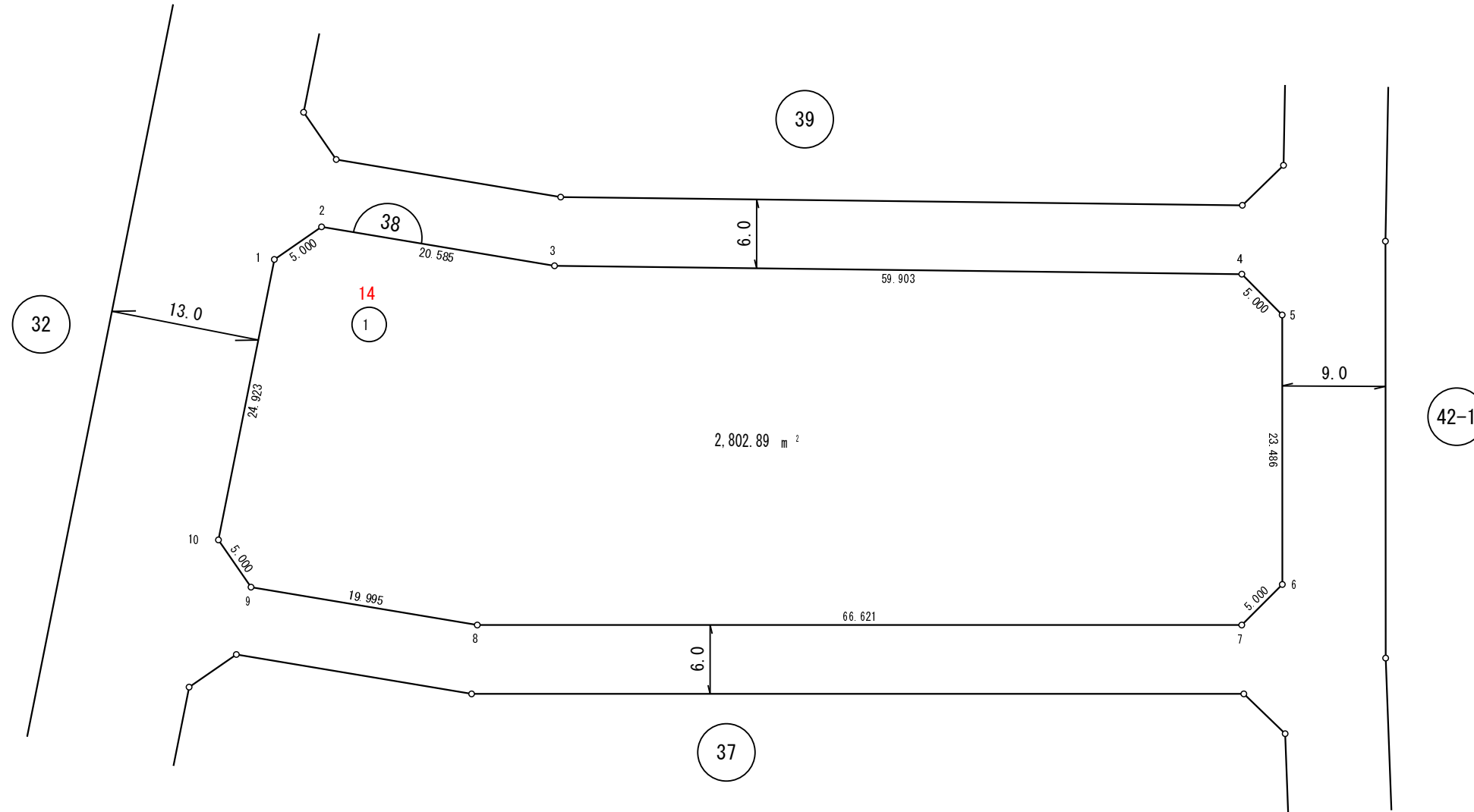
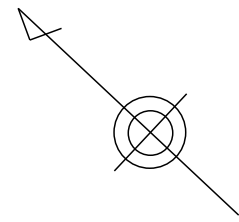

座標一覧表

測点名	X座標	Y座標
38-1	-9,784.180	10,777.944
38-2	-9,785.239	10,782.830
38-3	-9,802.373	10,794.240
38-4	-9,846.559	10,834.686
38-5	-9,851.555	10,834.497
38-6	-9,867.631	10,817.375
38-7	-9,867.472	10,812.378
38-8	-9,818.876	10,766.806
38-9	-9,802.233	10,755.725
38-10	-9,797.347	10,756.783

日本測地系

この図は、参考図で境界を証明するものではありません。
柏市役所

凡例	
	街区番号
	画地位置 (①は画地番号)
	画地面積 (m ²)
	辺長 (m)

船戸一丁目

座標一覧表

測点名	X座標	Y座標
37-1	-9804.255	10745.681
37-2	-9805.314	10750.567
37-3	-9822.617	10762.089
37-4	-9871.706	10808.123
37-5	-9876.706	10808.056
37-6	-9892.857	10792.079
37-7	-9892.945	10787.079
37-8	-9834.899	10725.468
37-9	-9832.578	10723.568
37-10	-9825.081	10718.904
37-11	-9820.212	10720.038
37-12	-9814.393	10756.613
37-13	-9821.294	10761.208
37-14	-9824.576	10763.926
37-16	-9857.476	10794.779
37-17	-9883.606	10801.229
37-18	-9885.192	10778.850
37-19	-9874.703	10767.717
37-20	-9864.736	10757.138
37-22	-9849.240	10740.690
37-23	-9834.152	10724.857
37-24	-9812.550	10732.350
37-25	-9824.762	10739.949
37-26	-9833.742	10749.480
37-29	-9852.727	10768.453
37-30	-9862.693	10779.032
37-31	-9868.100	10784.770
37-32	-9873.182	10790.165
37-33	-9811.742	10733.649
37-34	-9823.953	10741.248

日本測地系

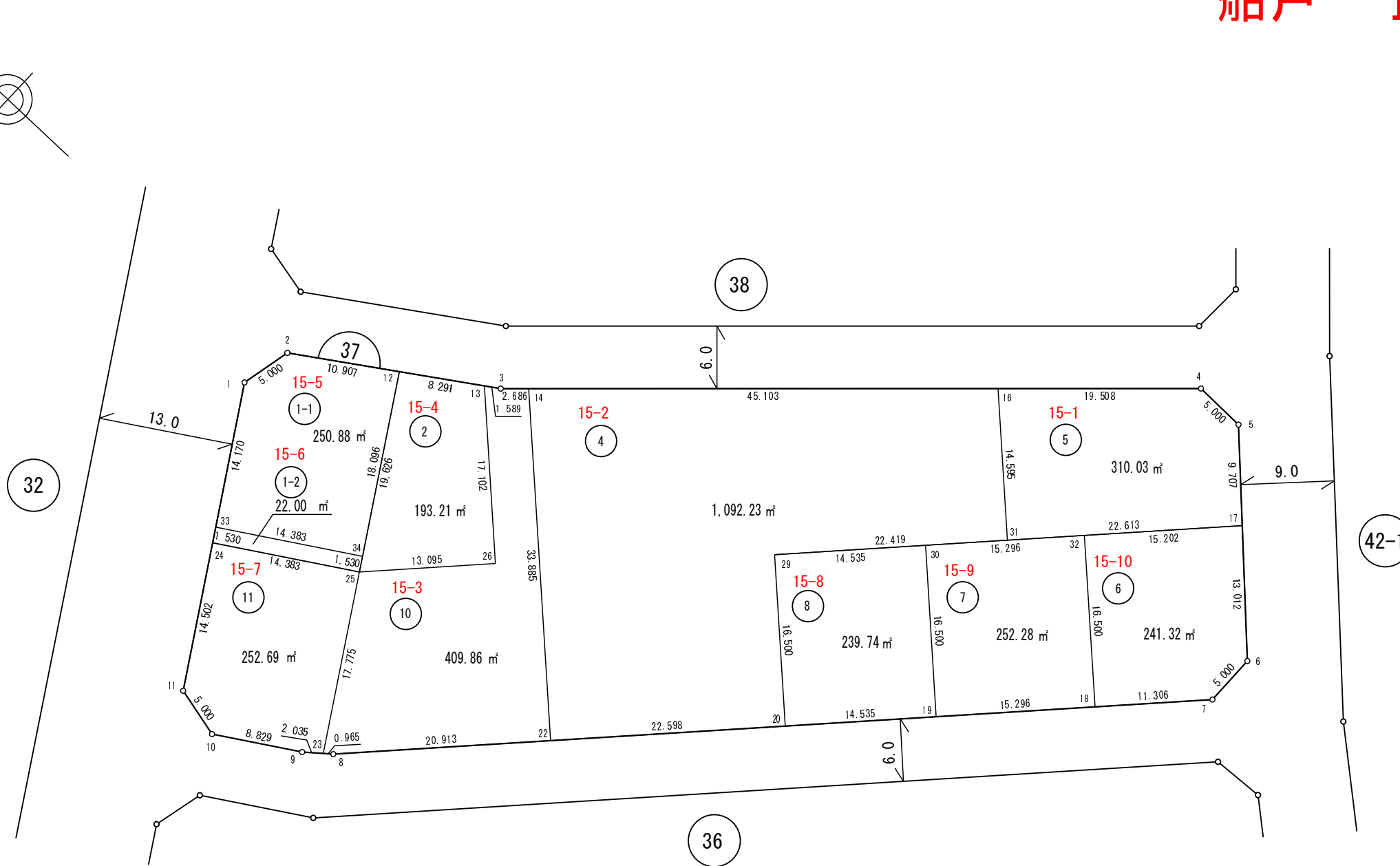

この図は、参考図で境界を証明するものではありません。
 柏市役所

凡例	
	街区番号
	画地位置 (①は画地番号)
	画地面積 (㎡)
	辺長 (m)

船戸一丁目

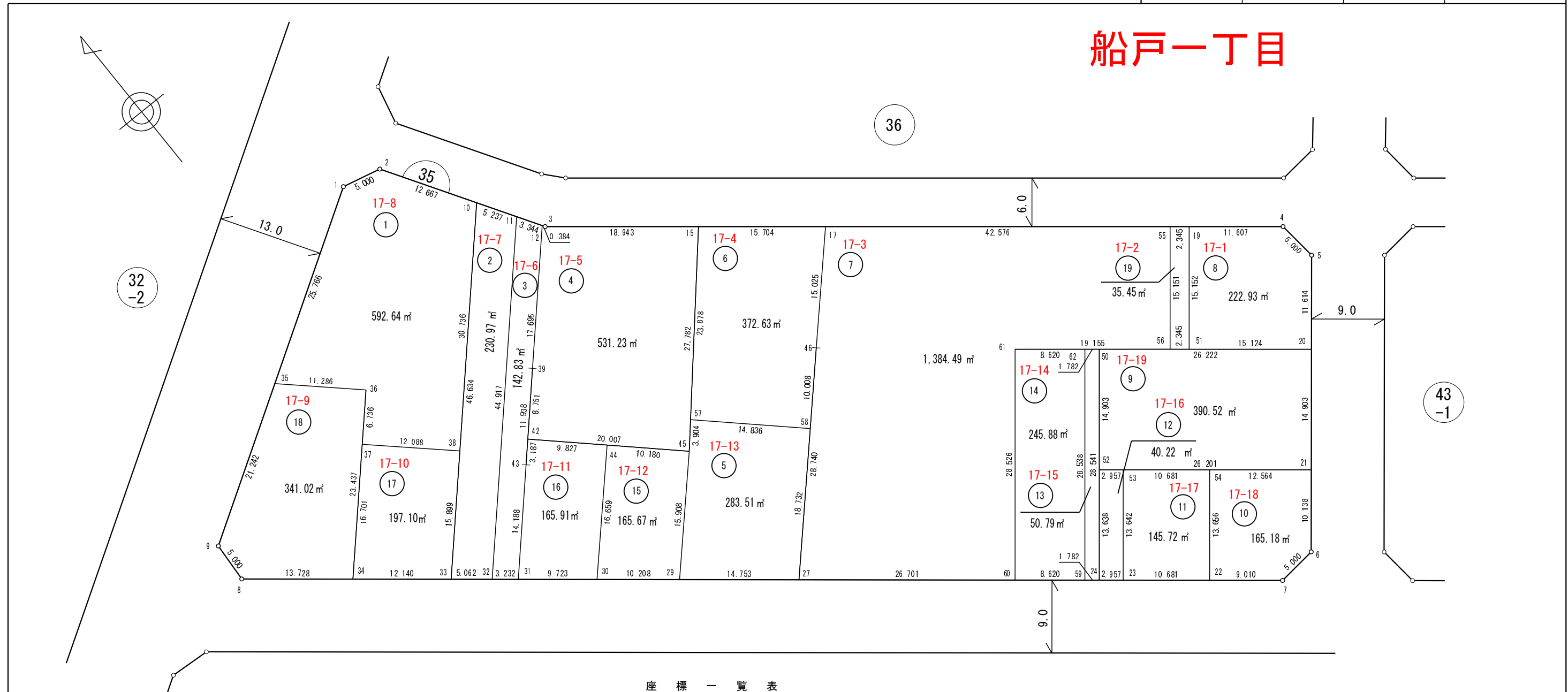

座標一覧表

34

測点名	X座標	Y座標
35-1	-9,851.125	10,670.357
35-2	-9,852.259	10,675.227
35-3	-9,870.625	10,686.655
35-4	-9,927.917	10,757.579
35-5	-9,932.889	10,758.104
35-6	-9,961.372	10,735.032
35-7	-9,961.894	10,730.059
35-8	-9,880.950	10,630.135
35-9	-9,875.960	10,630.445
35-10	-9,863.014	10,681.919
35-11	-9,867.460	10,684.685
35-12	-9,870.299	10,686.452
35-15	-9,882.528	10,701.390
35-17	-9,892.396	10,713.606
35-19	-9,920.623	10,748.550
35-20	-9,941.914	10,750.794
35-21	-9,953.494	10,741.413

測点名	X座標	Y座標
35-22	-9,956.222	10,723.058
35-23	-9,949.500	10,714.759
35-24	-9,947.638	10,712.461
35-27	-9,924.284	10,683.631
35-29	-9,914.998	10,672.167
35-30	-9,908.573	10,664.235
35-31	-9,902.453	10,656.680
35-32	-9,900.418	10,654.169
35-33	-9,897.232	10,650.235
35-34	-9,889.591	10,640.802
35-35	-9,864.737	10,648.481
35-36	-9,872.418	10,656.751
35-37	-9,877.353	10,652.167
35-38	-9,885.566	10,661.037
35-39	-9,883.277	10,674.424
35-42	-9,889.704	10,668.485
35-43	-9,892.045	10,666.322

測点名	X座標	Y座標
35-44	-9,896.435	10,675.645
35-45	-9,903.407	10,683.063
35-46	-9,903.333	10,703.304
35-50	-9,925.436	10,730.396
35-51	-9,932.410	10,739.029
35-52	-9,937.030	10,721.031
35-53	-9,938.888	10,723.331
35-54	-9,945.599	10,731.640
35-55	-9,919.150	10,746.726
35-56	-9,930.936	10,737.205
35-57	-9,900.473	10,685.638
35-58	-9,910.629	10,696.453
35-59	-9,946.517	10,711.077
35-60	-9,941.091	10,704.379
35-61	-9,918.900	10,722.304
35-62	-9,924.317	10,729.010

日本測地系

この図は、参考図で境界を証明するものではありません。
柏市役所

凡例	
	街区番号
	画地位置 (①は画地番号)
	画地面積 (㎡)
	辺長 (m)

この図は、参考図で境界を証明するものではありません。
柏市役所

船戸一丁目

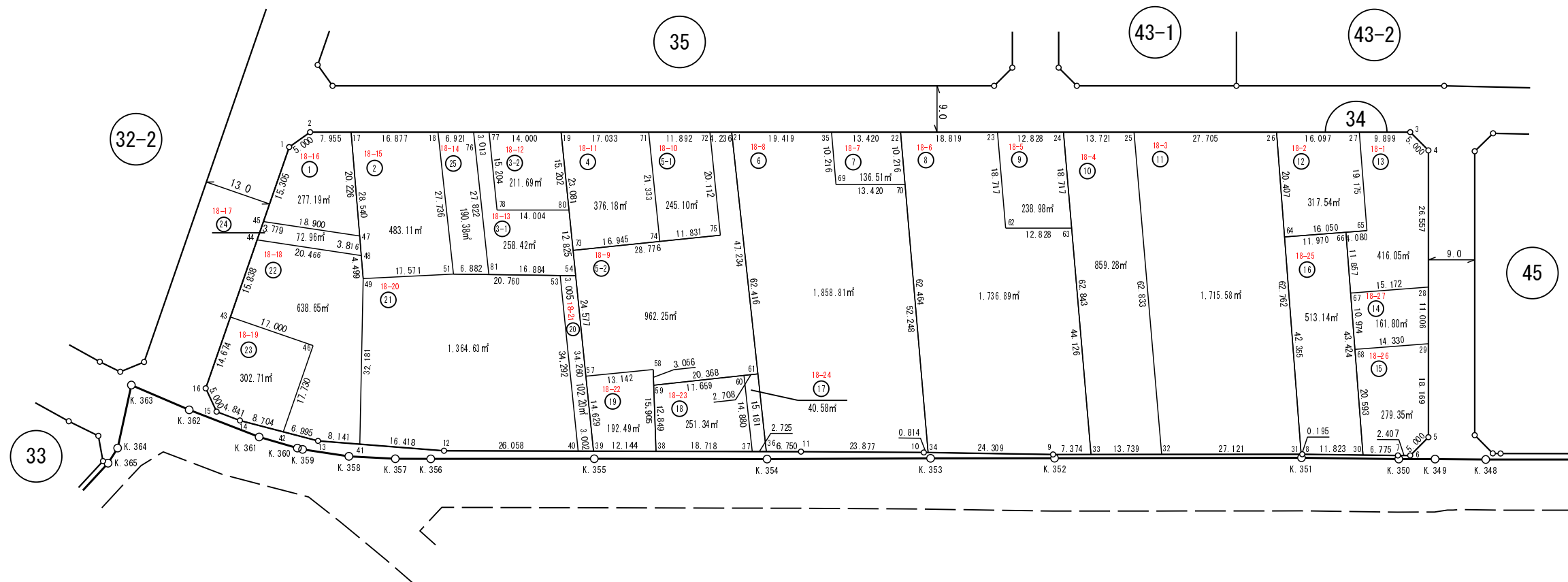
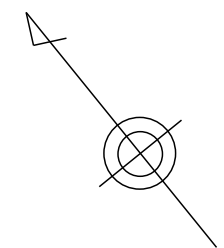

凡 例	
	街区番号
	画地位置 (①は画地番号)
	画地面積 (㎡)
	辺長 (m)

座 標 一 覧 表

測点名	X座標	Y座標
34-1	-9,884.890	10,616.093
34-2	-9,885.200	10,621.084
34-3	-10,019.797	10,787.243
34-4	-10,024.770	10,787.765
34-5	-10,068.076	10,752.684
34-6	-10,068.605	10,747.712
34-7	-10,067.095	10,745.838
34-8	-10,055.206	10,731.537
34-9	-10,024.755	10,693.879
34-10	-10,008.635	10,674.609
34-11	-9,993.486	10,656.153
34-12	-9,949.669	10,602.339
34-13	-9,932.776	10,584.514
34-14	-9,920.128	10,575.214
34-15	-9,915.945	10,572.778
34-16	-9,911.092	10,573.984
34-17	-9,890.207	10,627.265
34-18	-9,900.831	10,640.379
34-19	-9,915.896	10,658.977
34-21	-9,936.769	10,684.744
34-22	-9,957.439	10,710.262
34-23	-9,969.284	10,724.885
34-24	-9,977.359	10,734.853
34-25	-9,985.996	10,745.515
34-26	-10,003.434	10,767.043
34-27	-10,013.567	10,779.551
34-28	-10,045.406	10,771.048
34-29	-10,053.959	10,764.121
34-30	-10,062.764	10,740.628
34-31	-10,055.083	10,731.385
34-32	-10,038.030	10,710.296
34-33	-10,029.391	10,699.612
34-34	-10,009.158	10,675.233
34-35	-9,948.992	10,699.834
34-36	-9,989.224	10,650.919
34-37	-9,987.504	10,648.806
34-38	-9,975.685	10,634.291
34-39	-9,968.018	10,624.874

測点名	X座標	Y座標
34-40	-9,966.122	10,622.546
34-41	-9,938.376	10,590.423
34-42	-9,927.141	10,580.370
34-43	-9,903.340	10,586.442
34-44	-9,894.972	10,599.890
34-45	-9,892.976	10,603.099
34-46	-9,917.774	10,595.424
34-47	-9,906.914	10,615.864
34-48	-9,910.065	10,613.713
34-49	-9,913.781	10,611.177
34-51	-9,924.150	10,625.362
34-53	-9,937.427	10,641.322
34-54	-9,939.349	10,643.632
34-57	-9,955.776	10,632.884
34-58	-9,962.988	10,643.870
34-59	-9,965.428	10,642.029
34-60	-9,974.998	10,656.870
34-61	-9,976.465	10,659.147
34-62	-9,984.781	10,714.389
34-63	-9,992.856	10,724.357
34-64	-10,020.228	10,755.449
34-65	-10,029.347	10,768.657
34-66	-10,027.029	10,765.299
34-67	-10,036.786	10,758.562
34-68	-10,045.817	10,752.328
34-69	-9,957.450	10,694.105
34-70	-9,965.897	10,704.533
34-71	-9,926.617	10,672.213
34-72	-9,934.103	10,681.453
34-73	-9,935.210	10,646.340
34-74	-9,944.468	10,660.533
34-75	-9,950.932	10,670.442
34-76	-9,905.187	10,645.757
34-77	-9,907.084	10,648.099
34-78	-9,919.804	10,639.771
34-80	-9,928.617	10,650.654
34-81	-9,928.551	10,630.653

日本測地系

この図は、参考図で境界を証明するものではありません。
柏市役所

凡 例	
1	街区番号
①	画地位置 (①は画地番号)
1,234.00㎡	画地面積 (㎡)
9,000 2,000	辺長 (m)

この図は、参考図で境界を証明するものではありません。
柏市役所

船戸一丁目

1/2

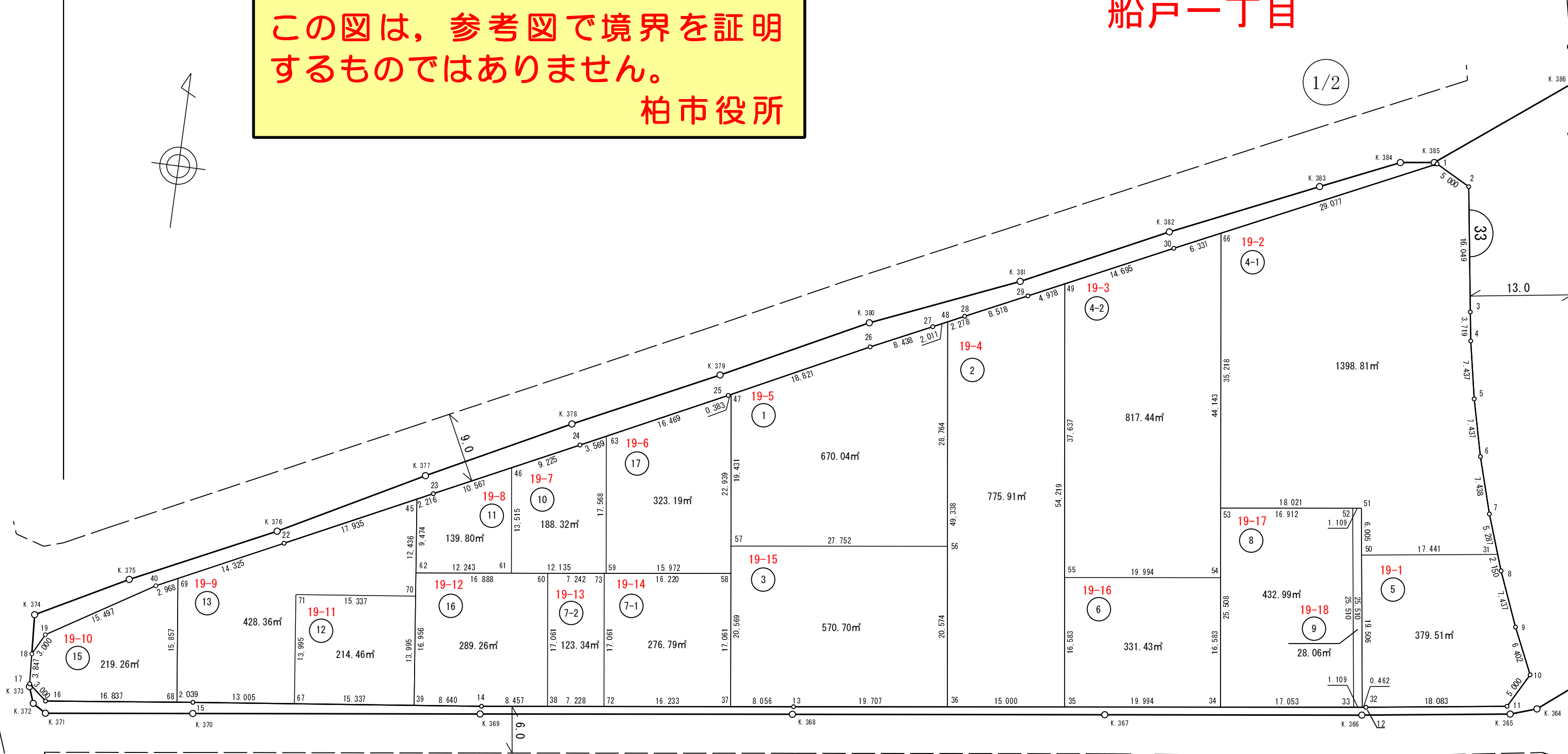
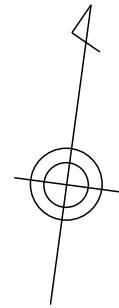

凡 例	
	街区番号
	画地位置 (①は画地番号)
	画地面積 (m²)
	辺長 (m)

座 標 一 覧 表

測点名	X座標	Y座標
33-1	-9841.847	10531.360
33-2	-9844.198	10535.773
33-3	-9860.073	10538.127
33-4	-9863.752	10538.672
33-5	-9871.048	10540.111
33-6	-9878.268	10541.895
33-7	-9885.396	10544.020
33-8	-9892.414	10546.481
33-9	-9899.307	10549.273
33-10	-9905.120	10551.955
33-11	-9909.512	10549.564
33-12	-9912.060	10531.661
33-13	-9921.829	10458.989
33-14	-9927.134	10419.369
33-15	-9931.595	10382.657
33-16	-9933.960	10363.930
33-17	-9932.047	10361.619
33-18	-9928.207	10361.380
33-19	-9925.544	10362.762
33-22	-9909.826	10391.496
33-23	-9900.964	10409.594
33-24	-9892.271	10427.375
33-25	-9883.424	10445.354
33-26	-9874.826	10462.526
33-27	-9871.179	10470.135
33-28	-9869.316	10473.999
33-29	-9865.633	10481.680
33-30	-9857.081	10499.397
33-31	-9890.385	10545.769
33-32	-9912.121	10531.203
33-33	-9912.269	10530.104
33-34	-9914.541	10513.203

測点名	X座標	Y座標
33-35	-9917.205	10493.387
33-36	-9919.204	10478.521
33-37	-9922.898	10451.004
33-38	-9926.012	10427.751
33-39	-9928.176	10410.792
33-40	-9917.424	10375.961
33-45	-9901.939	10407.604
33-46	-9896.323	10419.088
33-47	-9883.252	10445.696
33-48	-9870.306	10471.947
33-49	-9863.469	10486.163
33-50	-9892.804	10528.497
33-51	-9886.858	10527.664
33-52	-9887.006	10526.565
33-53	-9889.260	10509.804
33-54	-9898.106	10510.993
33-55	-9900.770	10491.178
33-56	-9898.813	10475.779
33-57	-9902.511	10448.274
33-58	-9905.988	10448.740
33-59	-9908.108	10432.909
33-60	-9909.102	10425.486
33-61	-9909.719	10420.882
33-62	-9911.344	10408.747
33-63	-9890.695	10430.577
33-66	-9854.357	10505.112
33-67	-9930.026	10395.567
33-68	-9931.850	10380.634
33-69	-9916.120	10378.628
33-70	-9914.284	10409.104
33-71	-9916.134	10393.879
33-72	-9925.053	10434.915
33-73	-9908.141	10432.664

日本測地系

この図は、参考図で境界を証明するものではありません。
柏市役所

凡 例	
	街区番号
	画地位置 (①は画地番号)
	画地面積 (㎡)
	辺長 (m)

この図は、参考図で境界を証明するものではありません。
柏市役所

船戸一丁目

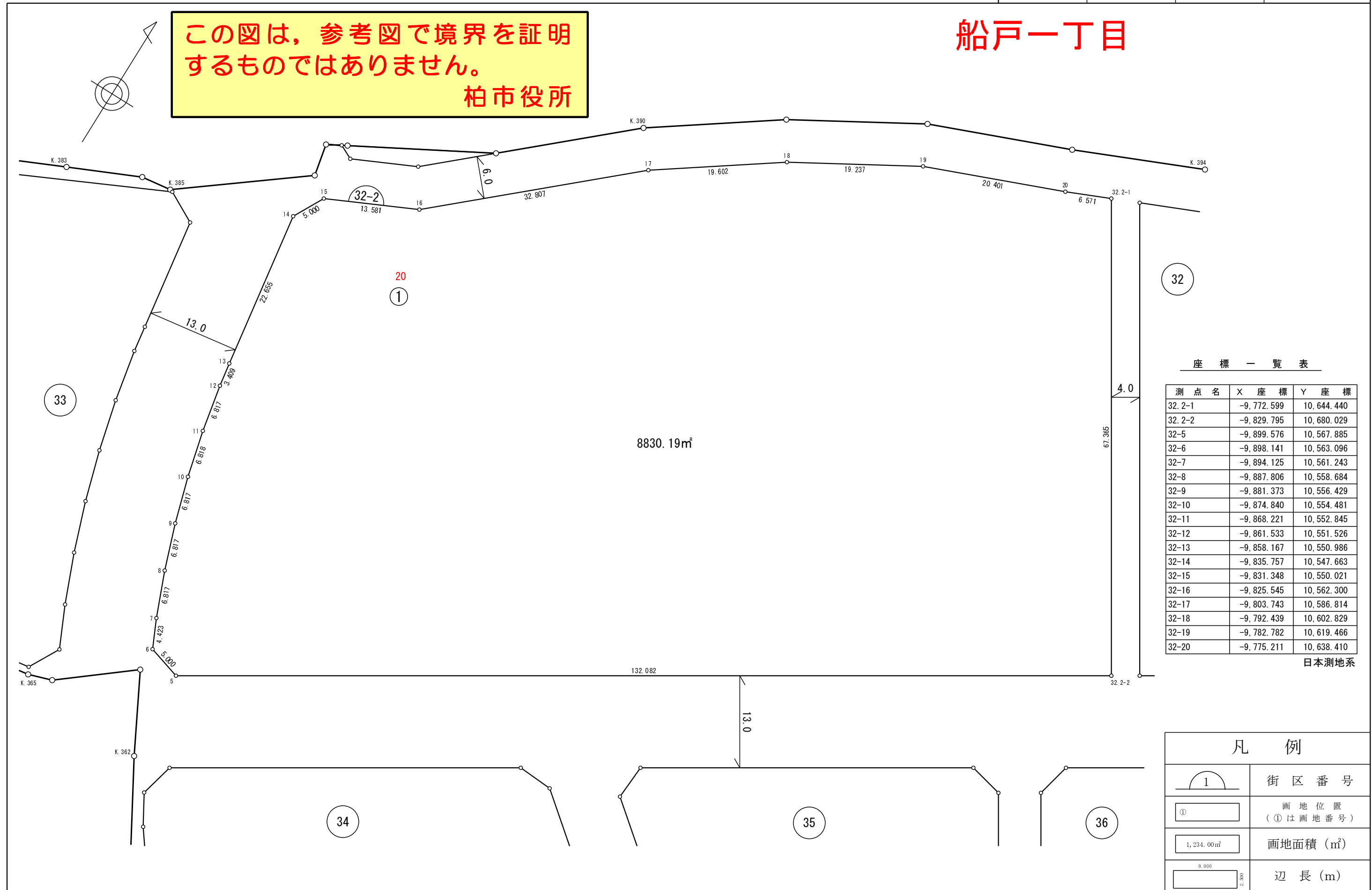

座標一覧表

測点名	X座標	Y座標
32-2-1	-9,772.599	10,644.440
32-2-2	-9,829.795	10,680.029
32-5	-9,899.576	10,567.885
32-6	-9,898.141	10,563.096
32-7	-9,894.125	10,561.243
32-8	-9,887.806	10,558.684
32-9	-9,881.373	10,556.429
32-10	-9,874.840	10,554.481
32-11	-9,868.221	10,552.845
32-12	-9,861.533	10,551.526
32-13	-9,858.167	10,550.986
32-14	-9,835.757	10,547.663
32-15	-9,831.348	10,550.021
32-16	-9,825.545	10,562.300
32-17	-9,803.743	10,586.814
32-18	-9,792.439	10,602.829
32-19	-9,782.782	10,619.466
32-20	-9,775.211	10,638.410

日本測地系

凡例

	街区番号
	画地位置 (①は画地番号)
	画地面積 (㎡)
	辺長 (m)

